

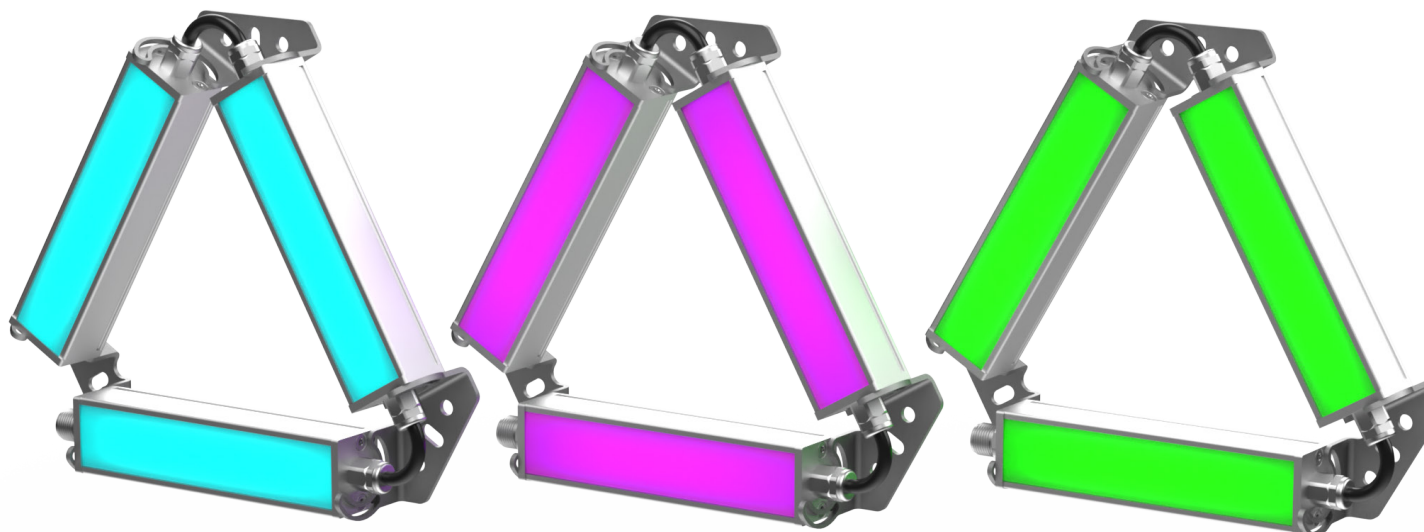







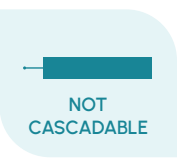
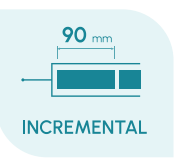
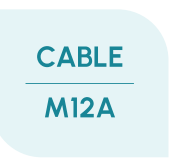

Triangular · P3D SERIES RGB

lumher

USER MANUAL



 <p>24 V DC</p>	 <p>PWM DIMABLE</p>	 <p>NOT CASCADABLE</p>	 <p>90 mm INCREMENTAL</p>	 <p>CABLE M12A</p>	 <p>RGB</p>
 <p>MACHINE VISION</p>	 <p>SIGNALING</p>	 <p>IP40 IP65</p>	 <p>CLASS III</p>	 <p>36 MONTHS</p>	 <p>EU MADE IN SPAIN</p>

1. Product Description

LED luminaire suitable for installation in electrical panels, machinery, home, elevators, machine vision, etc.

Structure made of silver anodized aluminum with multiple options. Equipped with the latest generation LEDs, the internal electronics allow direct connection to a power source, thus extending the life of the luminaire. In vision luminaires, a protection system is included to avoid exceeding the recommended triggering time.

2. Safety Tips

LUMHER luminaires have been manufactured according to the technical specifications specified for each model, using high-quality components and following a delicate production process. Each production detail has been carefully crafted, from the manufacture of the electronic circuit to the final packaging, maintaining all quality criteria.

Users should consider the following safety tips regarding the product.

- This manual should be kept close to the luminaire.
- It is important that users read all instructions before connecting the luminaire.
- Follow the instructions in this document.
- Install the product taking into account the safety risks specified in this document.
- LUMHER is not responsible for improper use of this luminaire.

2.1. Correct Use of the Luminaire

The product classification is IP40 or IP65 depending on the selected model, so this information must be considered when using the luminaire.

2.2. Product Safety

If the luminaire is not used correctly, it may be harmful to individuals due to electrical risks.

- The connection should ONLY be made by qualified personnel.
- Disconnect the power before performing any manipulation of the luminaire.
- The luminaire must comply with all the requirements indicated on the product label.
- Maintenance and repair should be carried out only by qualified personnel.
- There may be a risk of explosion if the luminaire is used in explosive environments.
- Do not install the luminaire in explosive environments.

Installation and Safety

- Avoid hitting the luminaire, even with packaging. It is a fragile product. Strong impacts may damage the luminaire.
- Use only the fastenings provided by the manufacturer.
- Properly use the mounting fixings.

- The luminaire must be securely fastened with the appropriate screws depending on the installation surface.
- Periodically check that the luminaire is properly installed.

Glare Hazard

- Avoid looking directly at the luminaire, as it may cause temporary vision problems, irritation, and eye pain.
- Do not look directly at the light source.
- Adjust the luminaire so that the light source does not directly impact the operator's eyes.

Hazard from Non-Original Spare Parts

- Always use original spare parts from the manufacturer.

Damage Due to High Temperatures

Install the luminaire in environments where there is no high temperature. A temperature above the maximum operating range can drastically reduce the luminaire's lifespan. Avoid direct sunlight.

Damage Due to Repairs

Do not disassemble or repair the equipment if not done by qualified personnel. Improper repairs may cause damage to people and objects.

In case of failure, do not repair; return to technical support.

Any modification of the product not performed by the technical service will void the warranty.

2.2. Risk Levels

DANGER: Risk in case of non-compliance. It may cause immediate injury or even death.

WARNING: Risk in case of non-compliance. It may cause injuries or even death.

ATTENTION: Risk in case of non-compliance. It may cause immediate injuries.

ADVICE: Risk in case of non-compliance. It may cause damage to objects.

3. Versions

The product code can be found on the luminaire label and packaging. Find the luminaire code on the packaging label and verify the item with the product label.

The barcode on the label shows the week and year of manufacture.

Do not remove the product label, as it will facilitate traceability in case of return due to failure or malfunction.

If the luminaire does not have a label, it will lose its warranty.

4. Technical specifications

Power supply voltage	24 Vdc \pm 5%	
Polarity	Positive PNP (common: 0 Vdc)	
PWM regulation (Max 25 KHz)	min. 0%	max. 100%
Max. number of cascadable modules	This luminaire is not cascadable	
Electrical protections	Transient overvoltages	YES
	Polarity reversal	YES
	Current stabilizer	YES
Beam angle	Semidiffuse	60°
	Ultradiffuse	110°
Wavelength	R = 625 nm G = 520 nm B = 465 nm	
IP Rating	IP40 o IP65	
Protection type	Class III	
Operating temperature	-10 a +40 °C	
Body material	Anodized aluminum	
Side cover material	Anodized aluminum	
Diffuser material	Polycarbonate	
Connection types	M12A, 2m cable, M12A connector with cable	
Standards	RoHs, CE	

5. Connection

M12A input - Cable	Power
Pin 1 - Brown	+24 Vdc (Green)
Pin 2 - White	+24 Vdc (Blue)
Pin 3 - Blue	0 Vdc
Pin 4 - Black	+24 Vdc (Red)

M12A Male

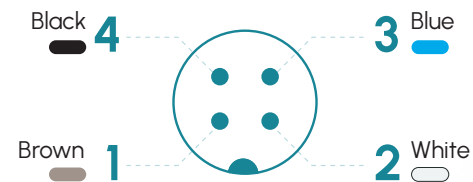

Fixings

P00R3, M6D16

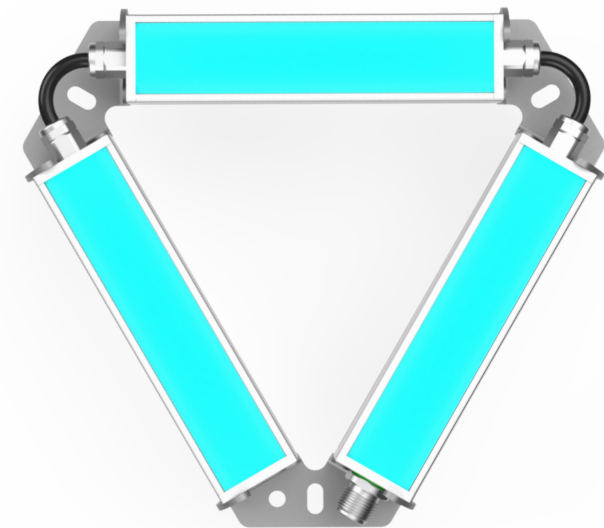

P3D · RGB

lumher

6. Measures

IP40 / IP65

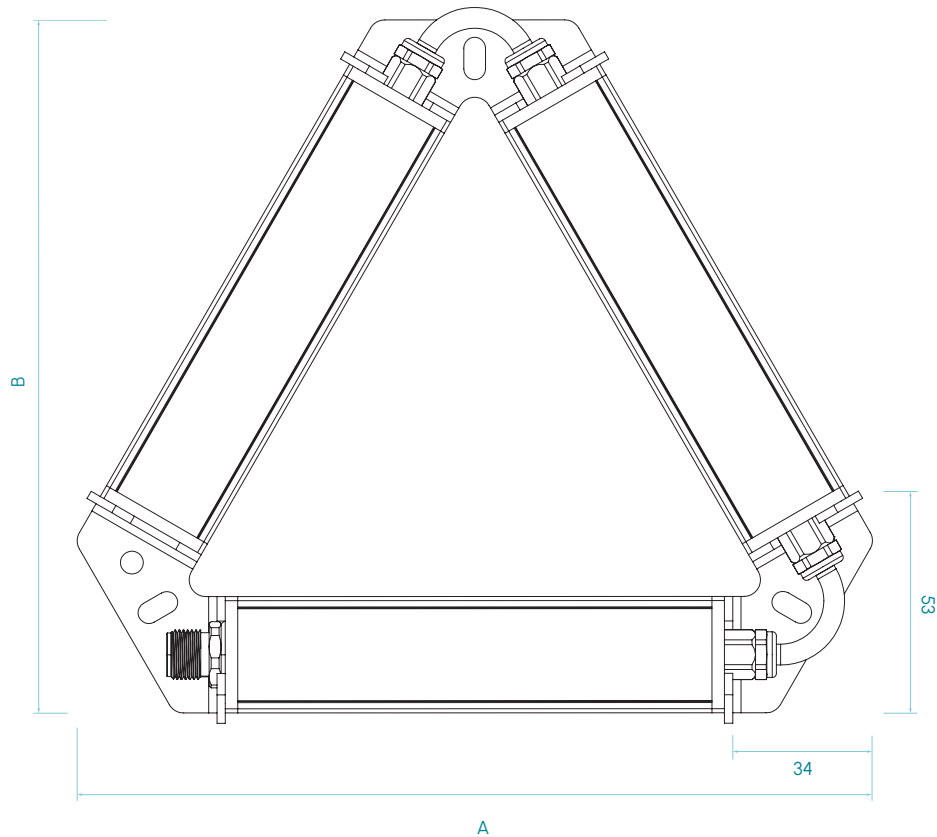

Measures in mm

P3D · RGB

7. Selection guide

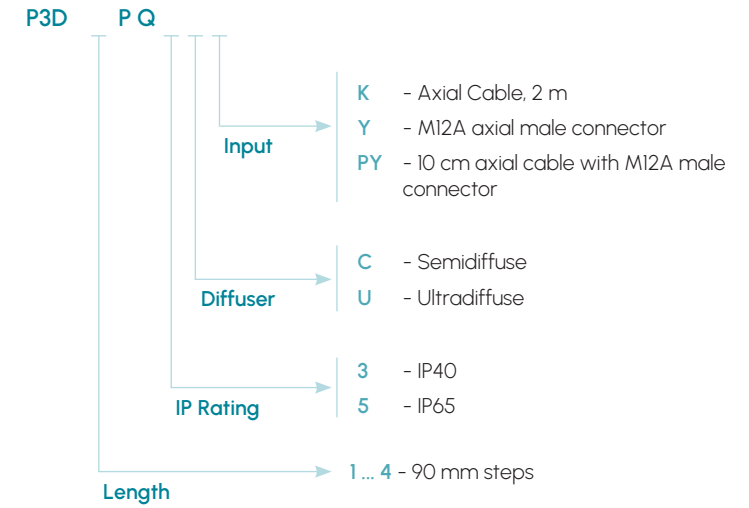

lumher

Modelos P3D · RGB

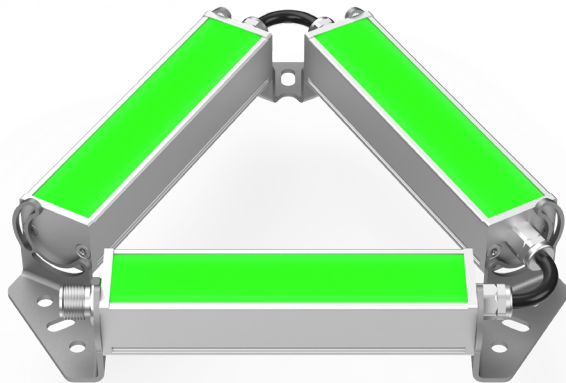
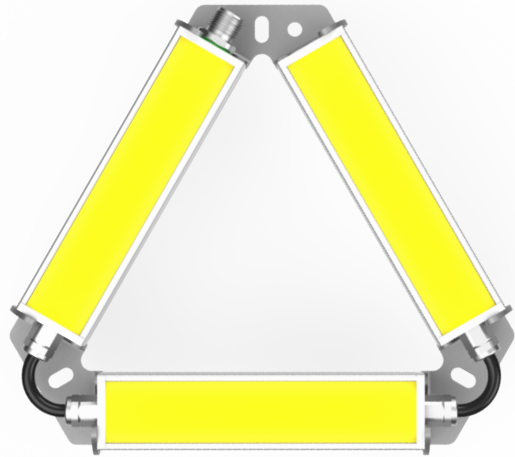

P3D · RGB

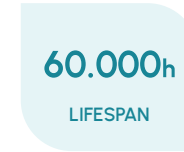
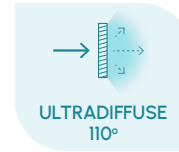
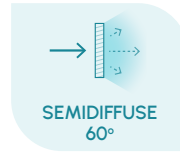

Table of characteristics

	Length	Length	Weight	Luminous flux ⁽¹⁾			Power consumed
	A	B		(lm)			
	(mm)	(mm)	(g)	R	G	B	(W)
P3D 1...	189	166	382	29	77	22	5,4
P3D 2...	279	242	526	58	155	43	10,8
P3D 3...	369	320	670	86	232	65	16,2
P3D 4...	459	398	814	115	310	86	21,6

(1) Luminous flux (lm) is before diffuser.

8. Connection

ADVICE - Liquid leaks into the luminaire can damage components and break the lamp.

Maintain input voltage within the permissible range; incorrect voltage will damage the LED driver. **Permitted voltage range: 24VDC±5%**

Improper wiring can cause lamp breakage, material, and personal damage. Electrical connection must be carried out by qualified personnel. Strictly follow the indications shown in the connection section to ensure correct polarity.

9. Switching On and Off

The luminaire does not have automatic on/off functionality. This function is only available in vision models and versions with a presence sensor.

The luminaire turns on when receiving voltage and turns off when the voltage is removed.

The luminaire allows PWM dimming (except for machine vision models).

10. Troubleshooting

If the lamp does not turn on:

- Check that the lamp is correctly connected to the power source.
- Verify that the polarity of the connection pins is correct.

If the lamp is defective, contact:
CONTAVAL S.L.U. (Lumher Technical Support)
Telf. +34 963 843 700
Email: service@lumher.es

11. Replacing the Light Source

The light source is adhered to the profile using thermal adhesive glue.

Thanks to the long lifespan of the LED, around 60,000 hours*, light source replacement will not be necessary if used as indicated in this manual.

In case the light source needs to be replaced, contact the technical department.

* Value for white LED

12. Product Maintenance and Cleaning

WARNING - Disconnect power before performing any maintenance tasks.

This product does not require special maintenance.

- Cleaning tasks should only be carried out after turning off the lamp and once the surfaces have cooled down.
- Then proceed to clean the lamp with a non-abrasive liquid and a soft cloth.
- Regularly check that the four mounting screws are properly tightened.

ADVICE - Liquid leaks can damage the lamp.

13. Repair and Warranty

During the product's lifespan, the warranty covers product analysis and repair exclusively by Lumher's technical department or an authorized distributor, including the following points:

- Custody of the material provided for repair
- Cost of components, including labor dedicated to the defective product

The warranty does not cover:

- Transportation, packaging, and shipping costs
- Deterioration or damage caused by:
 - Installation and/or operation different from what is described in this manual
 - Repairs or repair attempts by personnel not authorized by Lumher
 - Operation of the equipment in environmental conditions other than those specified in the luminaire's technical sheet
 - Damage caused by liquid leaks in the lamp
 - Damage during transportation due to not following proper indications or inadequate packaging (original packaging is recommended)

WARRANTY PERIOD: The warranty period is 36 months from the date of purchase. Once this period has expired, repair services will be provided at the cost of replacement parts and labor according to established rates.

14. Recycling

Disposal of Obsolete Electrical and Electronic Devices (Directive 2002/96/EC-WEEE):

The crossed-out trash bin symbol indicates that this product, as it contains electrical and electronic components, should not be mixed with untreated municipal waste. For more detailed information regarding the recycling of this product, check your country's waste disposal regulations. Do not dispose of this product as solid waste, even if it contains such components. Reuse or proper recycling of electrical or electronic equipment (EEE) is important to protect the environment and human health.

According to the European WEEE Directive 2002/96/EC, these types of products should be disposed of in electrical and electronic waste disposal areas. The equipment may be disposed of by the distributor when purchasing an equivalent. Public administrations and manufacturers of electrical and electronic equipment are involved in facilitating all processes for the reuse and recovery of discarded electrical and electronic equipment through collection campaigns using appropriate planning mechanisms.

Incorrect disposal of electrical or electronic waste may be punishable by law according to the sanctions established by each country.

15. Symbology

	CE Logo
	CLASS III DEVICE Device that works with extra-low voltages.
IP40 / IP65	IP Rating
	LED Technology
	Directive 2002/96/EC of the European Parliament and of the Council of 27 January 2003 on the disposal of Waste Electrical and Electronic Equipment (WEEE) (OJ L 37, 13.2.2003, p. 1).