

Ring · SERIE RD1 Infrarrojo 850 nm

lumher

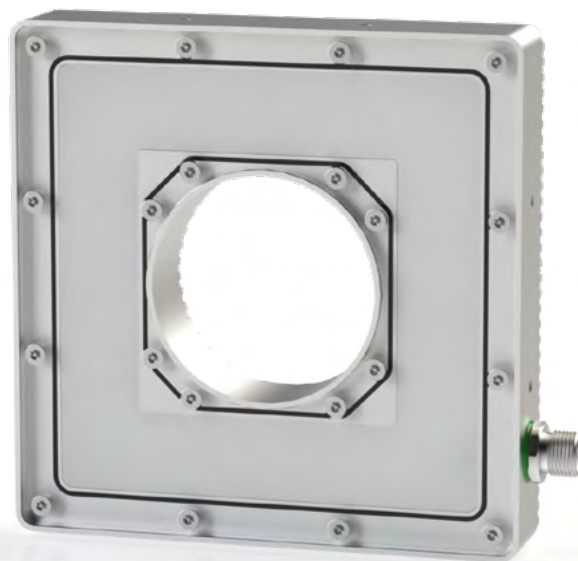

24 V
DC



NO
ENSERIBLE

IP65



M12A



VISIÓN

POWER 1x
STROBE 4x

CONTROLADOR



INTEGRADO

36
MESES



HECHO EN
ESPAÑA

Especificaciones técnicas

Tensión de alimentación	24 Vdc \pm 5%	
Entrada trigger	24 Vdc PNP	
Máximo tiempo de encendido	Power = Ilimitado	Strobe = 10 ms
Máximo ciclo de trabajo	Power = 1	Strobe = 1/6
Nº máximo de módulos enseriados	Luminaria no enseriable	
Longitud de onda	Infrarrojo	850 nm
Ángulo de apertura	Semidifuso	110°
	Ultradifuso	110°
Protecciones eléctricas	Sobretensiones transitorias	SI
	Inversión de polaridad	SI
	Estabilizador de corriente	SI
Grado de protección	IP65	
Tipo de protección	Clase III	
Temperatura de operación	-10 a +40 °C	
Material del cuerpo	Aluminio anodizado	
Material del difusor	Plástico PMMA	
Tipo de conexión	Conector M12A	
Normativas	RoHs, CE	

Conexionado

Entrada M12A	Power	Máster Power - Strobe
Pin 1 - Marrón	+24 Vdc	+24 Vdc
Pin 2 - Blanco	Sin conectar	Sin conectar
Pin 3 - Azul	0 Vdc	0 Vdc
Pin 4 - Negro	Sin conectar	Trigger PNP

M12A Macho

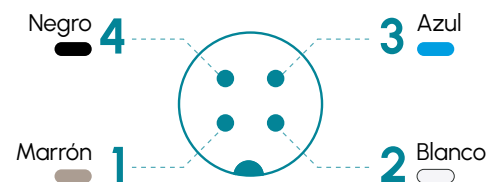

Anclajes

B00S1

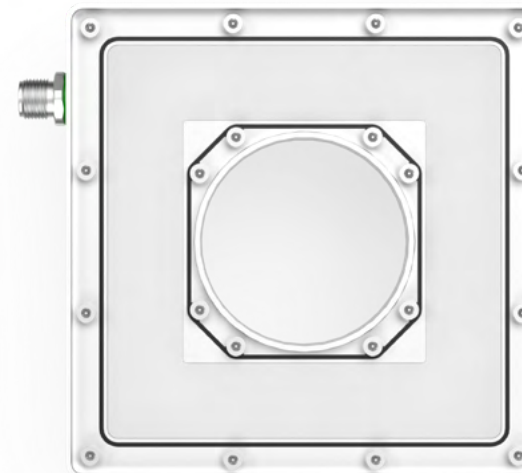

RD1 · 850 nm

lumher

Dimensiones

RD1

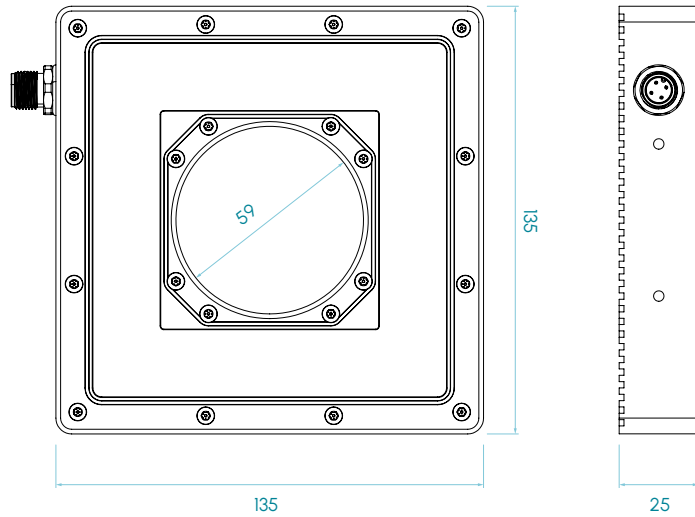

Tipos disponibles

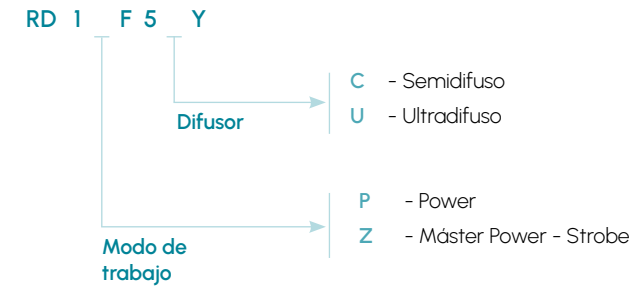

Medidas en mm

RD1 · 850 nm

lumher

Modelo RD1 · Infrarrojo 850 nm

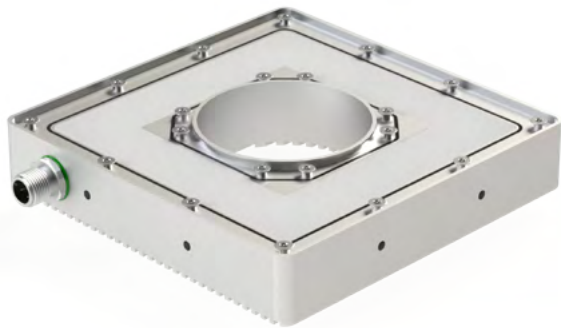
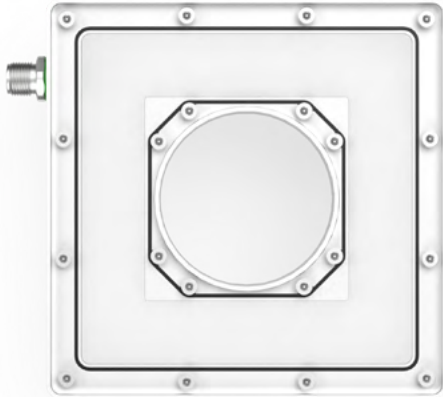

850nm

INFRARROJO



SEMIDIFUSO
110°



ULTRADIFUSO
110°

RIESGO
FOTOBIOLOGICO
RG1 - BAJO

60.000h

VIDA ÚTIL

Tabla de características

	Ancho (mm)	Largo (mm)	Peso (g)	Potencia radiada ⁽¹⁾ (lm)		Potencia consumida (W)	
				POWER	STROBE	POWER	STROBE
RD1 ...	135	135	615	1,6	6,4	4,0	16,0

(1) La potencia radiada (W) es antes de difusor.