

Functional · PC Series White 3000K - Sensor · Switch

lumher

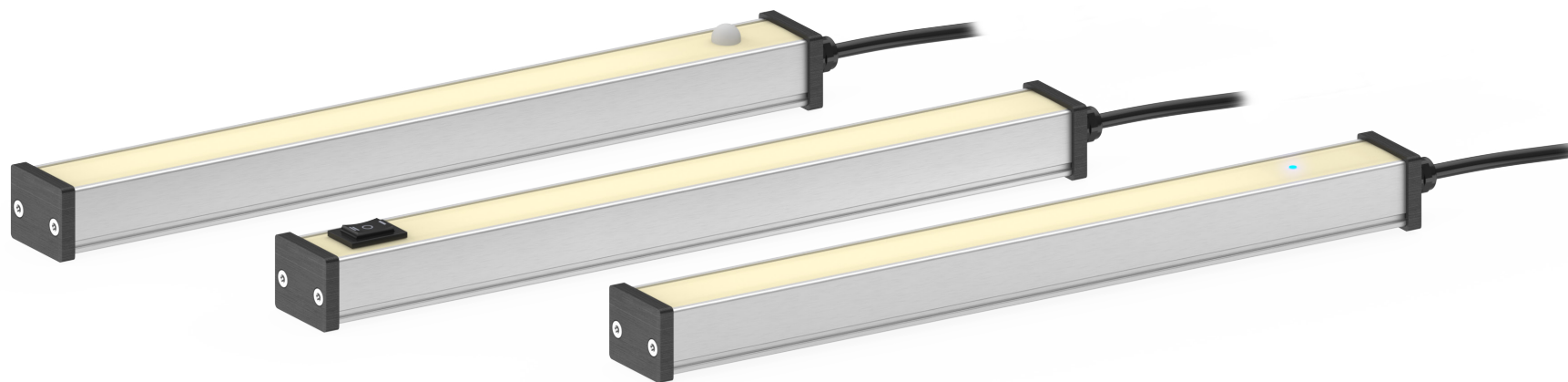

24 V
DC

155
lm/W

NOT
CASCADABLE

75 mm
INCREMENTAL

FUNCTIONAL

TACTILE

PIR

SWITCH

POWER 1x
ECO 0,5x

IP40

PWM
DIMABLE

CABLE
M12A

CLASS III

36
MONTHS

MADE IN SPAIN

Technical specifications

Power supply voltage	24 Vdc ±5%	
Luminous efficiency	125 lm/W	
Motion sensor disconnection delay (PIR)	5 min.	
Wavelength	Warm white	3000K
Angle of aperture	Semidiffuse	60°
	Ultradiffuse	110°
Max. number of cascable modules	This luminaire is not cascable	
Electrical protections	Transient overvoltages	YES
	Polarity reversal	YES
	Current stabilizer	YES
Colour Rendering Index (CRI)	≥ 90	
IP Rating	IP40	
Protection type	Class III	
Operating temperature	POWER version	-10 a +40 °C
	ECO version	-10 a +50° C
Body material	Anodized aluminum	
Side cover material	SLA resin	
Diffuser material	Polycarbonate	
Connection types	2m cable	
Standards	RoHs, CE	

Connection

Input M12A - Cable	Power	Eco	Dual
Pin 1 - Brown	+24 Vdc	+24 Vdc	+24 Vdc
Pin 2 - White	Not connected	Not connected	24 Vdc = Power 0 Vdc = Eco
Pin 3 - Blue	0 Vdc	0 Vdc	0 Vdc
Pin 4 - Black ⁽¹⁾	24 Vdc = Power on 0 Vdc = Switched on by motion sensor or touch sensor		

(1) Pin 4 is not connected in the switch version

M12A Male

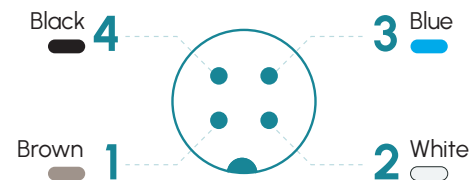

Anchors

P00G1 , P00G2, P00G3

PC · 3000K

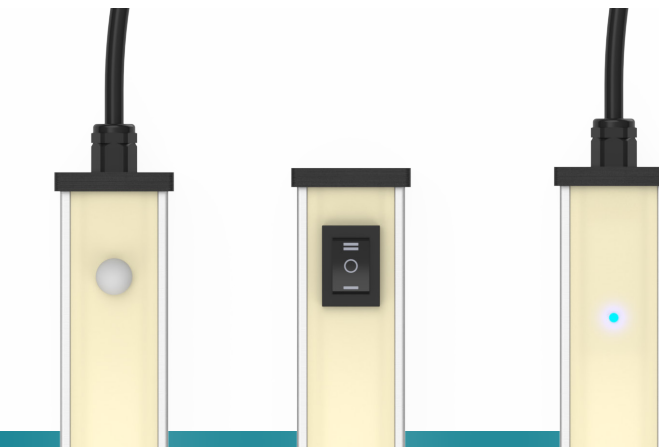

lumher

Dimensions

Tactile sensor + M12A axial input

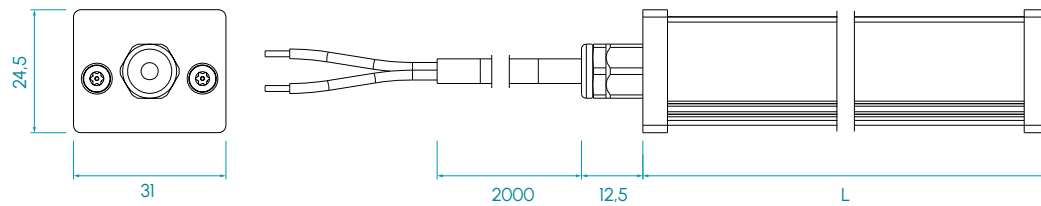

Motion sensor + M12A axial input

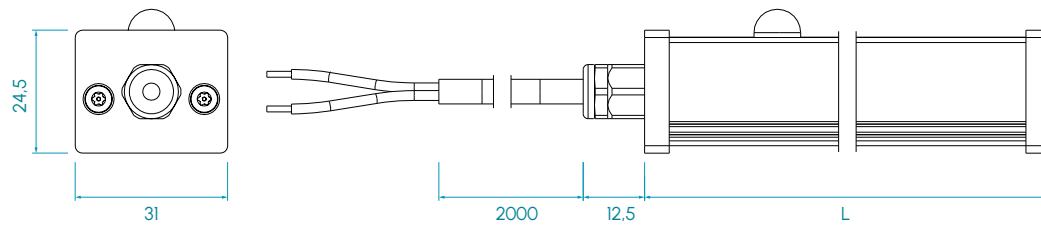

Switch + M12A radial input

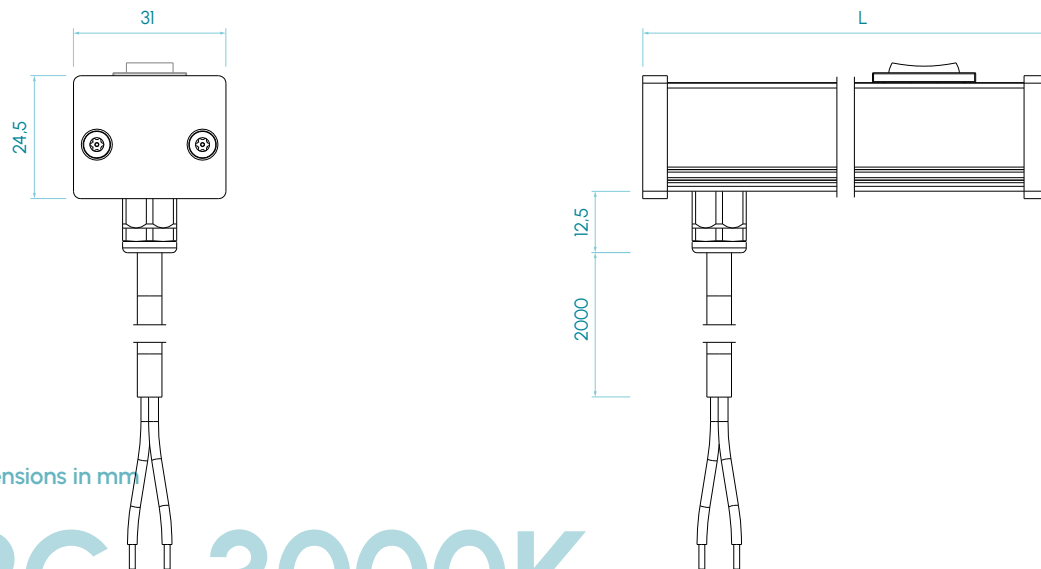

Dimensions in mm

PC · 3000K

Selection guide

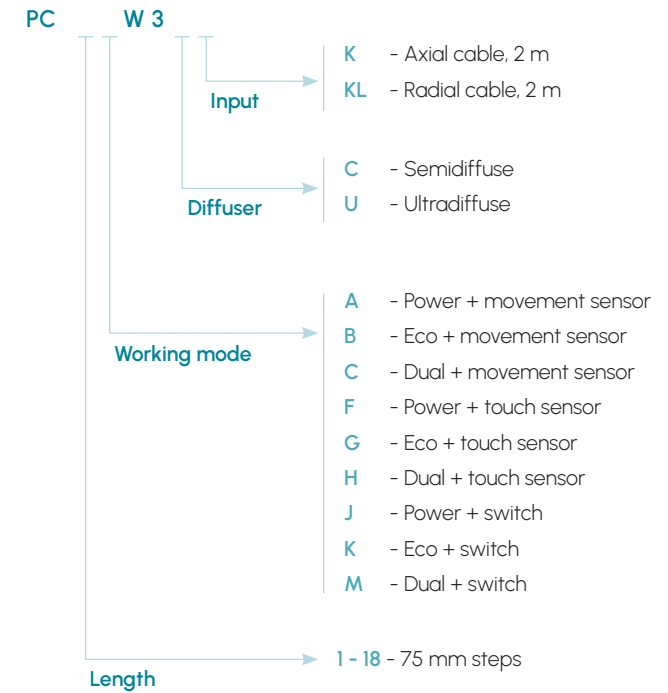

PC Series · Warm white 3000K Sensor · Switch

3000K

WARM WHITE



SEMI-DIFFUSE
60°



ULTRA-DIFFUSE
110°

PHOTOBIOLOGICAL
RISK

RG1 - LOW

60.000h

LIFESPAN

Table of characteristics

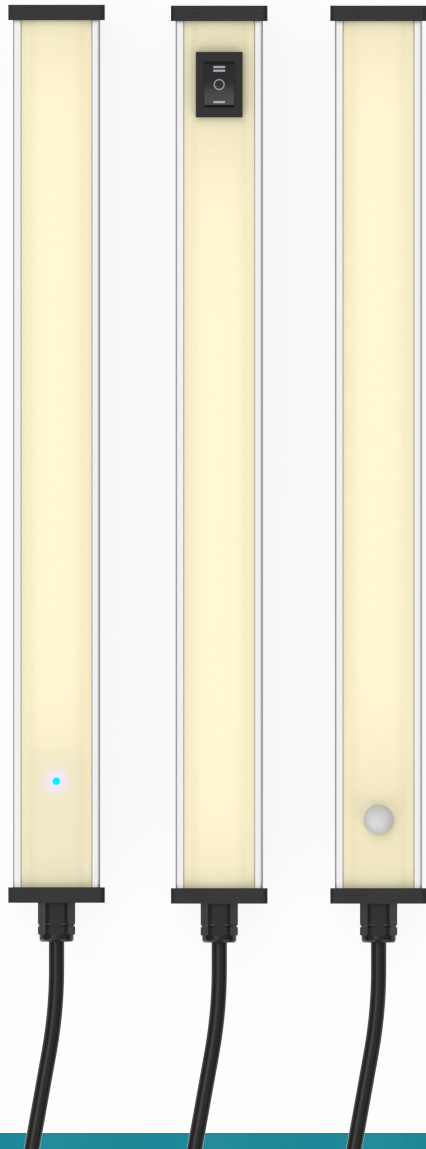

	Length L1 ⁽²⁾ (mm)	Length L2 ⁽²⁾ (mm)	Weight (g)	Illuminance Ev (lx) @ 1m				Luminous flux ⁽³⁾ (lm)		Power consumed (W)	
				SEMI-DIFFUSE		ULTRA-DIFFUSE		POWER	ECO	POWER	ECO
				POWER	ECO	POWER	ECO				
PC 01...	140	158	89	41	21	25	12	195	98	1,6	0,8
PC 02...	215	233	129	82	41	49	25	390	195	3,2	1,6
PC 03...	290	308	169	123	62	74	37	586	293	4,8	2,4
PC 04...	365	383	209	164	82	99	49	781	390	6,4	3,2
PC 05...	440	458	249	205	103	124	61	976	488	8,0	4,0
PC 06...	515	533	289	246	124	148	74	1.171	586	9,6	4,8
PC 07...	590	608	329	287	144	173	86	1.366	683	11,2	5,6
PC 08...	665	683	369	327	165	198	98	1.562	781	12,8	6,4
PC 09...	740	758	409	368	185	222	110	1.757	878	14,4	7,2
PC 10...	815	833	449	409	206	247	123	1.952	976	16,0	8,0
PC 11...	890	908	489	450	226	272	135	2.147	1.074	17,6	8,8
PC 12...	965	983	529	491	247	296	147	2.342	1.171	19,2	9,6
PC 13...	1.040	1.058	569	532	268	321	160	2.538	1.269	20,8	10,4
PC 14...	1.115	1.133	609	573	288	346	172	2.733	1.366	22,4	11,2
PC 15...	1.190	1.208	649	614	309	371	184	2.928	1.464	24,0	12,0
PC 16...	1.265	1.283	689	655	329	395	196	3.123	1.562	25,6	12,8
PC 17...	1.340	1.358	729	696	350	420	209	3.318	1.659	27,2	13,6
PC 18...	1.415	1.433	769	737	371	445	221	3.514	1.757	28,8	14,4

(2) Versions with radial input and/or radial output will have as length L2, the rest will be L1.
 (3) The luminous flux (lm) is before diffuser.