

Triangular · P3D SERIES Red 625 nm

lumher

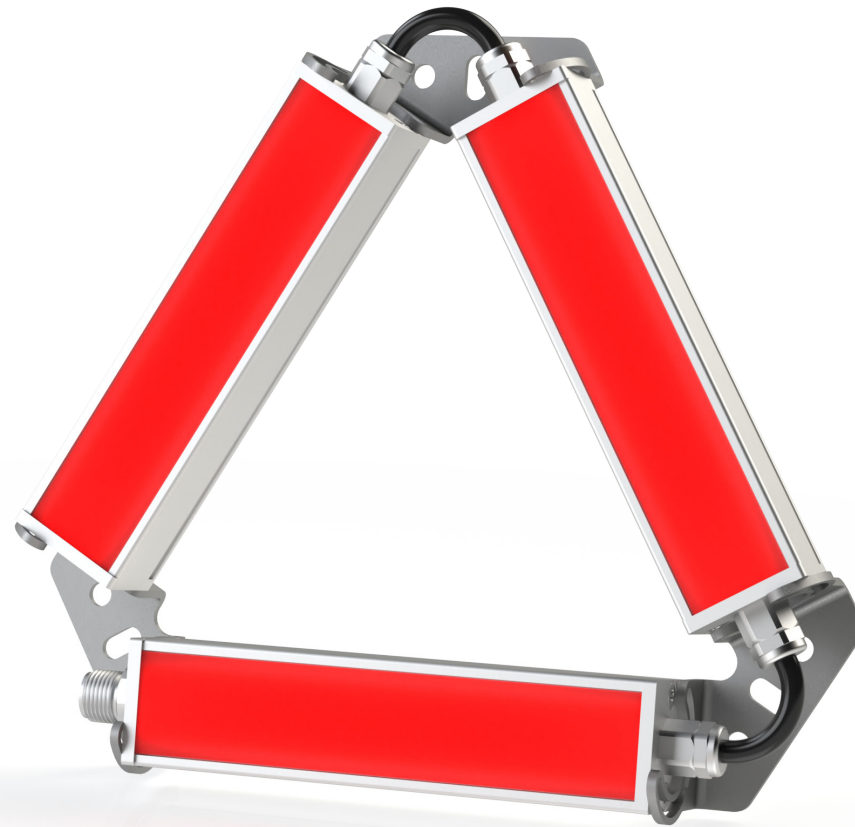

24 V
DC

NOT
CASCADABLE

90 mm
INCREMENTAL

CABLE
M12A

MACHINE VISION

POWER 1x
STROBE 4x

INTEGRATED
CONTROLLER

IP40
IP65

36
MONTHS

MADE IN SPAIN

Technical specifications

Power supply voltage	24 Vdc ±5%	
Trigger input	24 Vdc PNP	
Max. on time	Power = unlimited	Strobe = 10 ms
Max. working cycle	Power = 1	Strobe = 1/6
Max. number of cascable modules	This luminaire is not cascable	
Wavelength	Red	625 nm
Angle of aperture	Semidiffuse Ultradiffuse	60° 110°
Electrical protections	Transient overvoltages Polarity reversal Current sablizer	YES YES YES
IP Rating	IP40 o IP65	
Protection type	Class III	
Operating temperature	-10 a +40 °C	
Body material	Anodized aluminum	
Side cover material	Anodized aluminum	
Diffuser material	Polycarbonate	
Connection types	M12A, 2m cable, M12A connector with cable	
Standards	RoHs, CE	

P3D · 625 nm

Connection

M12A input - Cable	Power	Master Power - Strobe
Pin 1 - Brown	+24 Vdc	+24 Vdc
Pin 2 - White	Not connected	Not connected
Pin 3 - Blue	0 Vdc	0 Vdc
Pin 4 - Black	Not connected	Trigger PNP

M12A Male

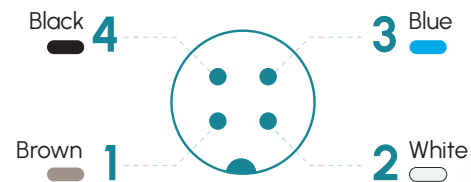

Fixings

P00R3, M6D16

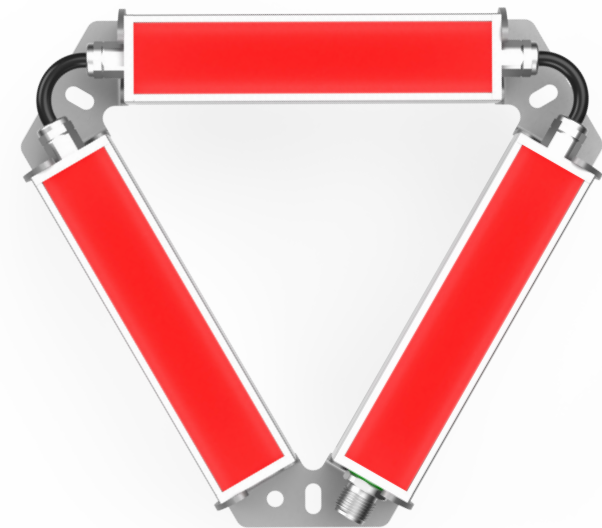

lumher

Measures

IP40 / IP65

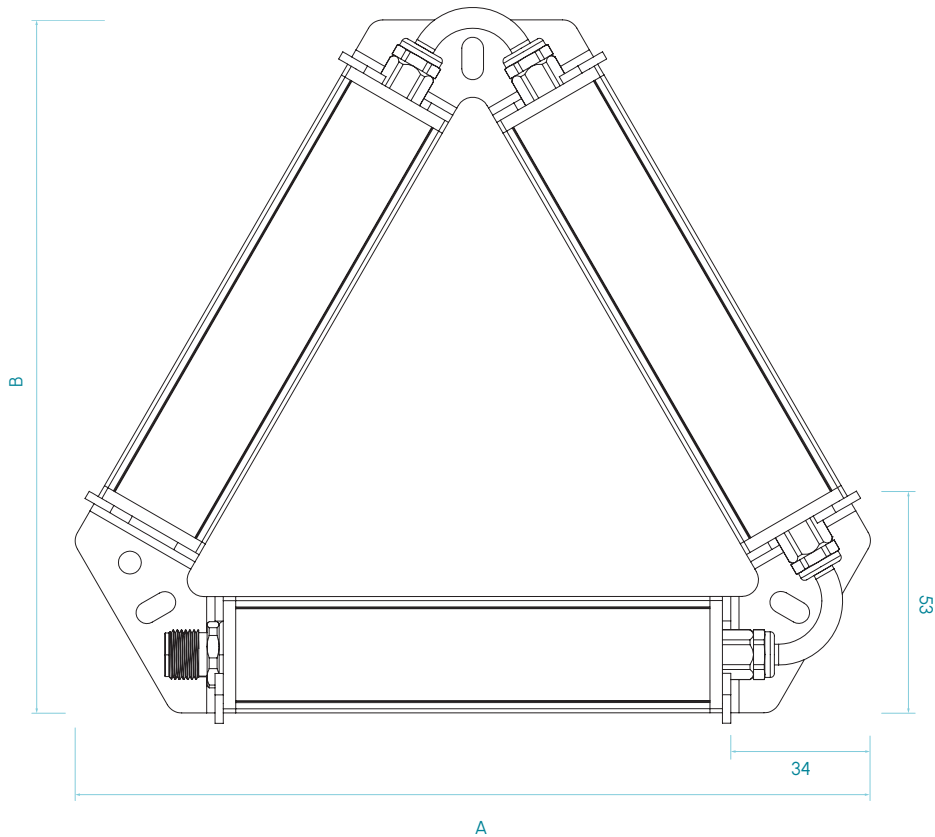

Measures in mm

P3D · 625 nm

Selection guide

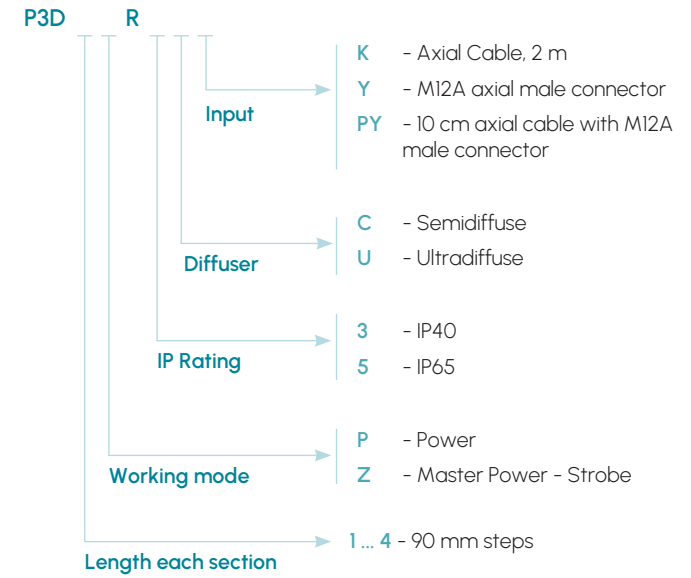

lumher

Model P3D · Red 625 nm

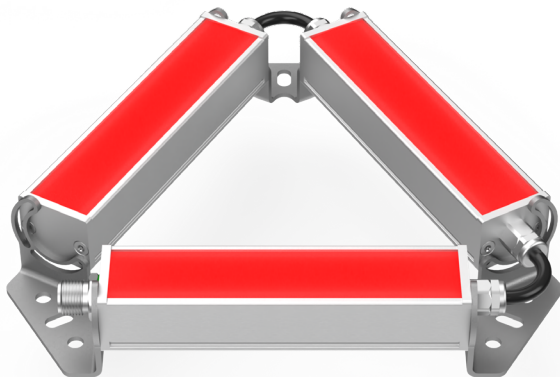

625nm

RED

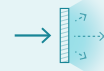

SEMIDIFFUSE
60°



ULTRADIFFUSE
110°

PHOTOBIOLOGICAL
RISK

RG1 - LOW

60.000h

LIFESPAN

Table of characteristics

	Length	Length	Weight (g)	Luminous flux ⁽¹⁾ (lm)		Power consumed (W)	
	A	B		POWER	STROBE	POWER	STROBE
	(mm)	(mm)					
P3D 1...	189	166	382	291	1.163	5,7	22,8
P3D 2...	279	242	526	581	2.326	11,4	45,6
P3D 3...	369	320	670	872	3.488	17,1	68,4
P3D 4...	459	398	814	1.163	4.651	22,8	91,2

(1) Luminous flux (lm) is before diffuser.